

Installation and Operation Instruction

The actuator types **FlowCon FN.0.2**, **FN.0.4** and **FN.1.2** are electrical actuators. FN.0.2 is 24V modulating and FN.0.4 is 24V 3-point floating and 2-position. FN.1.2 is 24V modulating and 2-position failsafe version.

Fitting and Re-fitting



Do not connect power to the actuator unless the actuator is already fitted on the valve and NEVER install the actuator in closed position - this may damage the valve. Actuator is supplied in open position to ensure easy commissioning of the system.

Mount the actuator on the valve and finger tighten the connection union. Do not use additional tools. In case the actuator will have to be removed, it is recommended to electrically open the actuator by activating DIP switch #6 for easier removal. Hereafter finger loosen the connection union. Again, no need for additional tools. Please make sure that the actuator is electrically opened, before re-fitting it on the valve.

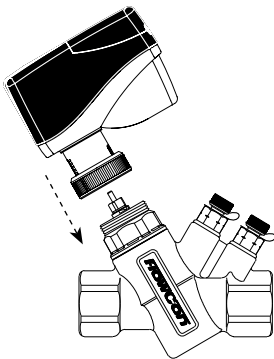

Figure 1

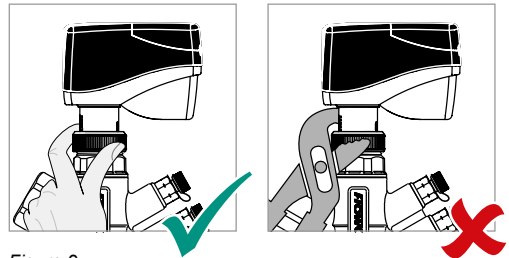

Figure 2

Orientation

Upside-down installation is allowed along with the standard horizontal and vertical installation.

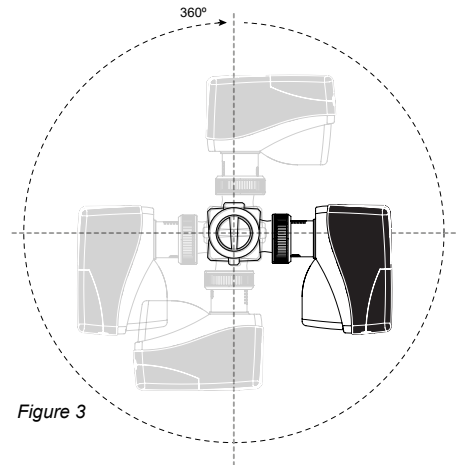

Figure 3

FlowCon FN.0.2, FN.0.4 and FN.1.2 Actuators

1B95080 - 09/2021

Wiring

FlowCon FN (analog)

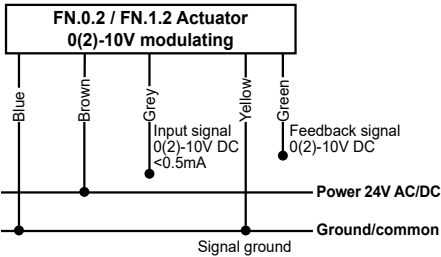

FlowCon FN (digital)

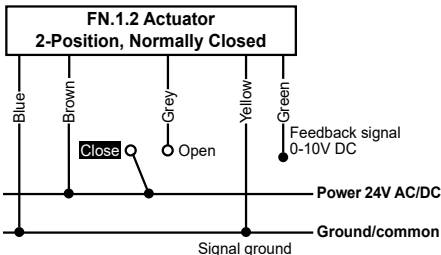
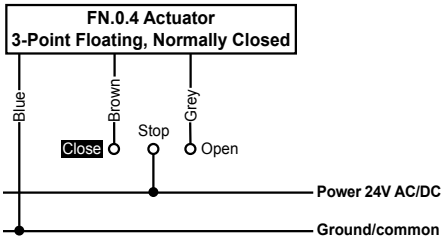
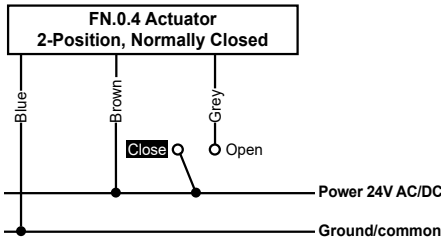

Start-up Sequence

When power to the actuator is turned on, the actuator will automatically calibrate to determine closing point. Hereafter it will proceed to normal operation mode (according to control signal).

For the failsafe version (FN.1.2), capacitor charging will be prioritized (max. 120 sec depending on capacitor energy level) during start-up and re-powering. After completion of charging mode followed by calibration mode, the actuator will proceed to normal operation mode.

Auto Cycle Sequence

Auto Cycle can be activated during commissioning. It prevents the valve from jamming when the valve is not moved for a longer period of inactivity. By moving DIP switch #1 from OFF to ON, Auto Cycle is activated. Actuator will then perform 50% stroke cycle every 3 weeks if no stroke movement has occurred.

Electrical Override

By moving DIP switch #6 from OFF to ON, electrical override is activated and the actuator will open valve fully. During electrical override the LED indicator will blink red and green. When DIP switch #6 is moved back to OFF, the actuator will re-calibrate and thereafter go into normal operation mode. Electrical override is performed with power supply on.











Failsafe Mode (FlowCon FN.1.2)

When power is lost, the actuator will go into failsafe mode after a few seconds, mandatory that capacitor charging and start-up sequence are completed. The actuator will perform failsafe action (open or close) and stay in failsafe final position until return of power. Upon power, the actuator remains in the final failsafe position until charging mode is reached (max. 60 sec). Hereafter the actuator will return to normal operation mode.





DIP Switch Settings

The valve functions are set on DIP switches found under the connection cover. PCB mounted electrical components will not be directly exposed when DIP switches are to be set. Factory setting for all switches is OFF.











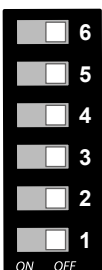

FlowCon FN.0.2 Actuator

DIP switch	Function ON		Function OFF
#6	 Electrical override ON		 Electrical override OFF
#5	No function		No function
#4	 Equal percentage		 Linear
#3	 Normally Open		 Normally Closed
#2	 Control signal 2-10V		 Control signal 0-10V
#1	 Auto cycle ON		 Auto cycle OFF

FlowCon FN.0.4 Actuator

DIP switch	Function ON		Function OFF
#6	 Electrical override ON		 Electrical override OFF
#5	No function		No function
#4	No function		No function
#3	 Normally Open		 Normally Closed
#2	No function		No function
#1	No function		No function

FlowCon FN.1.2 Actuator

DIP switch	Function ON		Function OFF
#6	 Electrical override ON		 Electrical override OFF
#5	 Failsafe open		 Failsafe close
#4	 Equal percentage		 Linear
#3	 Normally Open		 Normally Closed
#2	 Control signal 2-10V		 Control signal 0-10V
#1	 Auto cycle ON		 Auto cycle OFF

LED Status

The LED indicator is visible through the dark colored transparent connection cover. The LED indication will give the following statuses.

	FN.0.2	FN.0.4	FN.1.2
Normal operation mode	Full on green	Full on green	Full on green
Charging mode (60 sec)	n/a	n/a	Blinking red
Calibration mode (closing point adjustment)	Blinking green	Blinking green	Blinking green
Electrical override mode	Blinking red/green	Blinking red/green	Blinking red/green
Failsafe mode	n/a	n/a	OFF
Perpetual failure mode	Full on red	Full on red	Full on red

Re-Calibration

Re-calibration can be achieved in one of 2 ways:

1. Forced individual actuator re-calibration can also be performed by flipping DIP switch #6 from OFF to ON and back to OFF on the relevant actuator.
2. Forced concurrent re-calibration for all modulating actuators (FN.0.2/FN.1.2) is electrical-ly possible. Within 60 sec. provide the following electrical control signal sequence to the grey wire: 10V-2V-10V-2V-10V-2V to achieve re-calibration.

After re-calibration the actuator will go into normal operation mode.